

5

4

3

2

1

D

D

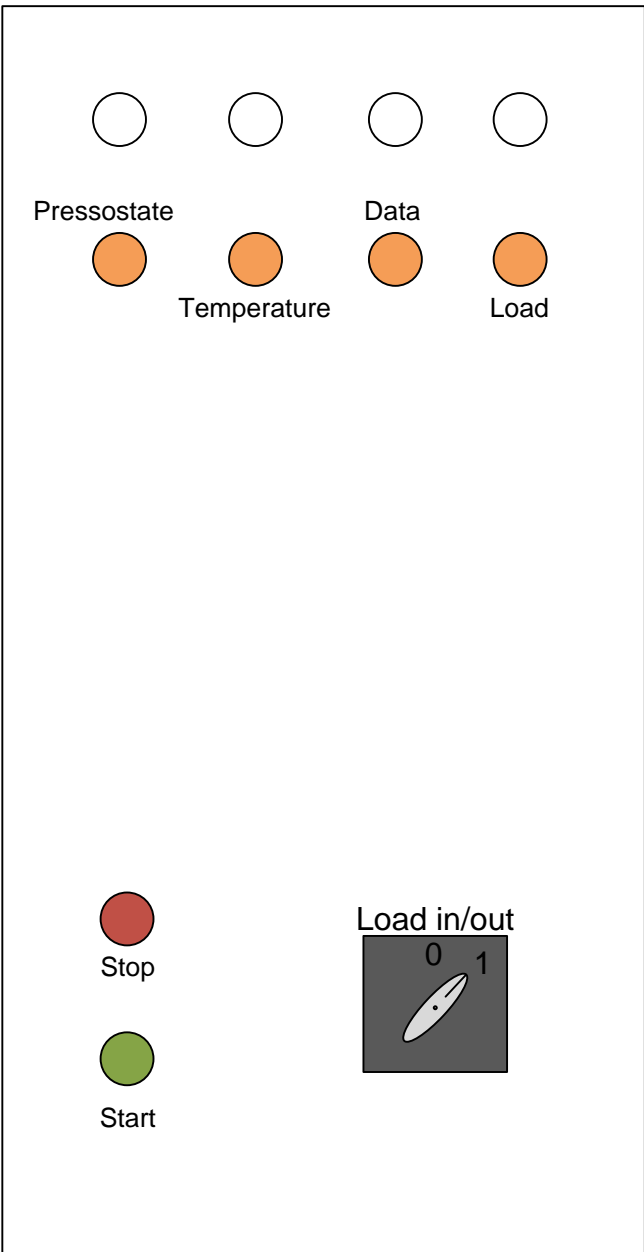

C

C

B

B

A

A

5

4

3

2

1

 NTNU Institutt for teknisk kybernetikk		Forfatter: Rune Mellingseter
S3 – Skapoversikt dør		
Mål: A4	Prosjekt: ABB-lab	Rev: 1
Dato: Onsdag, 22 September, 2010	Side:	1 av 1

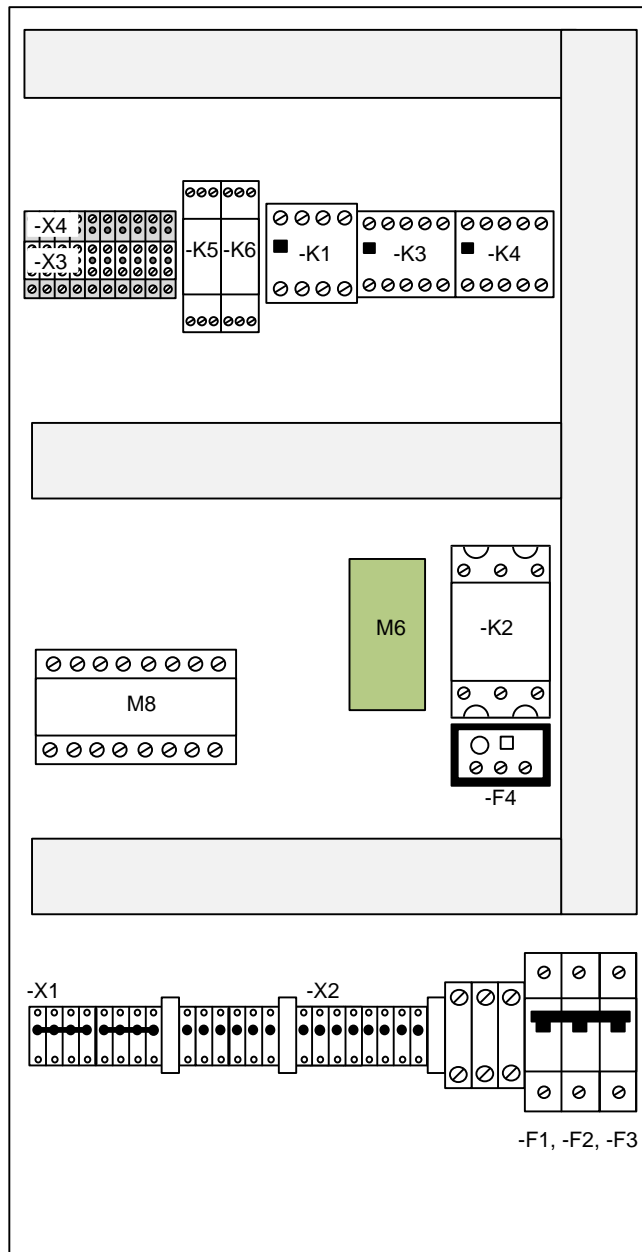

 NTNU Institutt for teknisk kybernetikk		Forfatter: Rune Mellingseter
S3 - Skapoversikt		
Mål: A4	Prosjekt: ABB-lab	Rev: 1
Dato:	Torsdag, 04 Juni, 2009	Side: 1 av 1

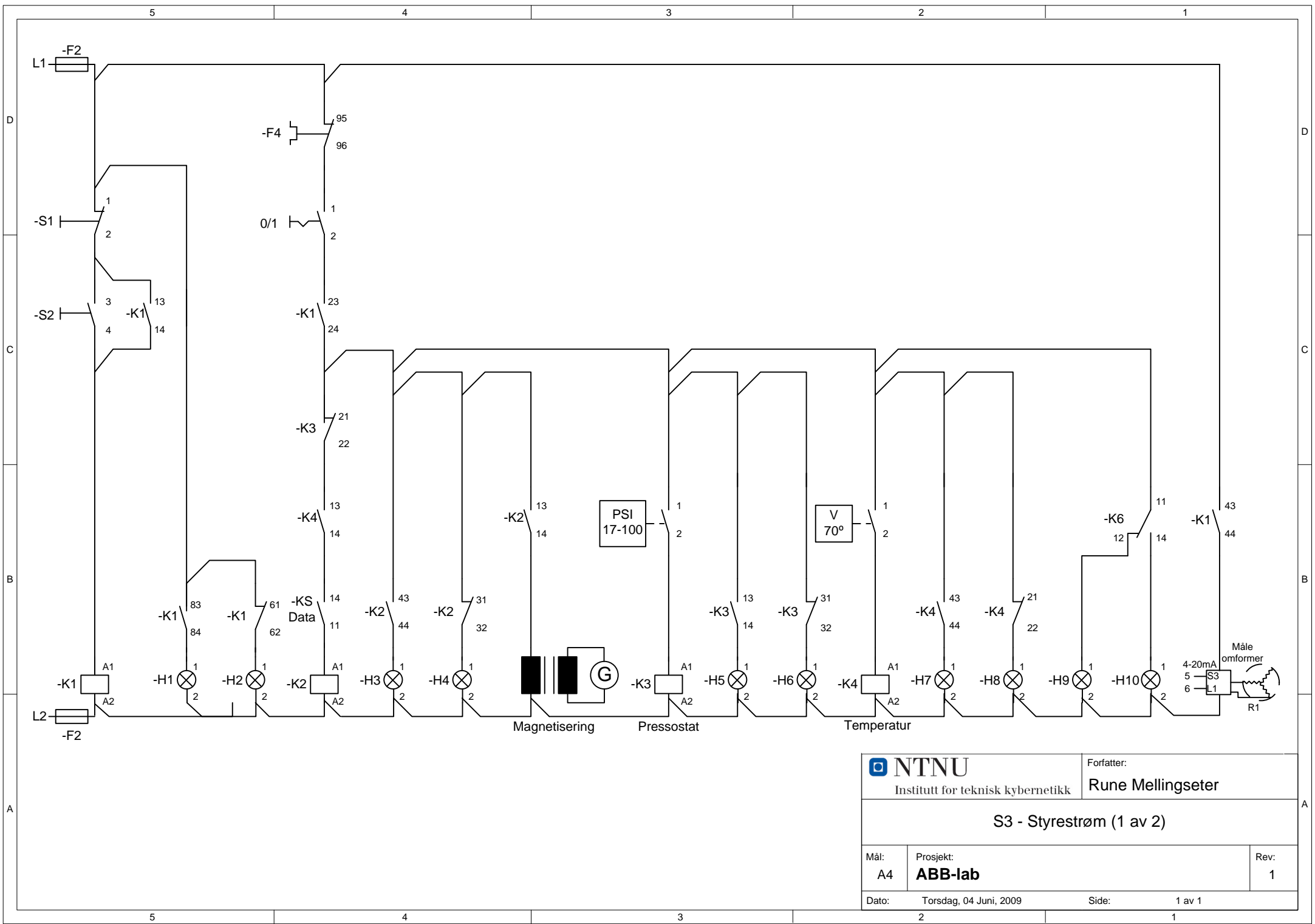

S3 - Styrestrøm (1 av 2)

Mål: A4	Prosjekt: ABB-lab	Rev: 1
Dato: Torsdag, 04 Juni, 2009		Side: 1 av 1

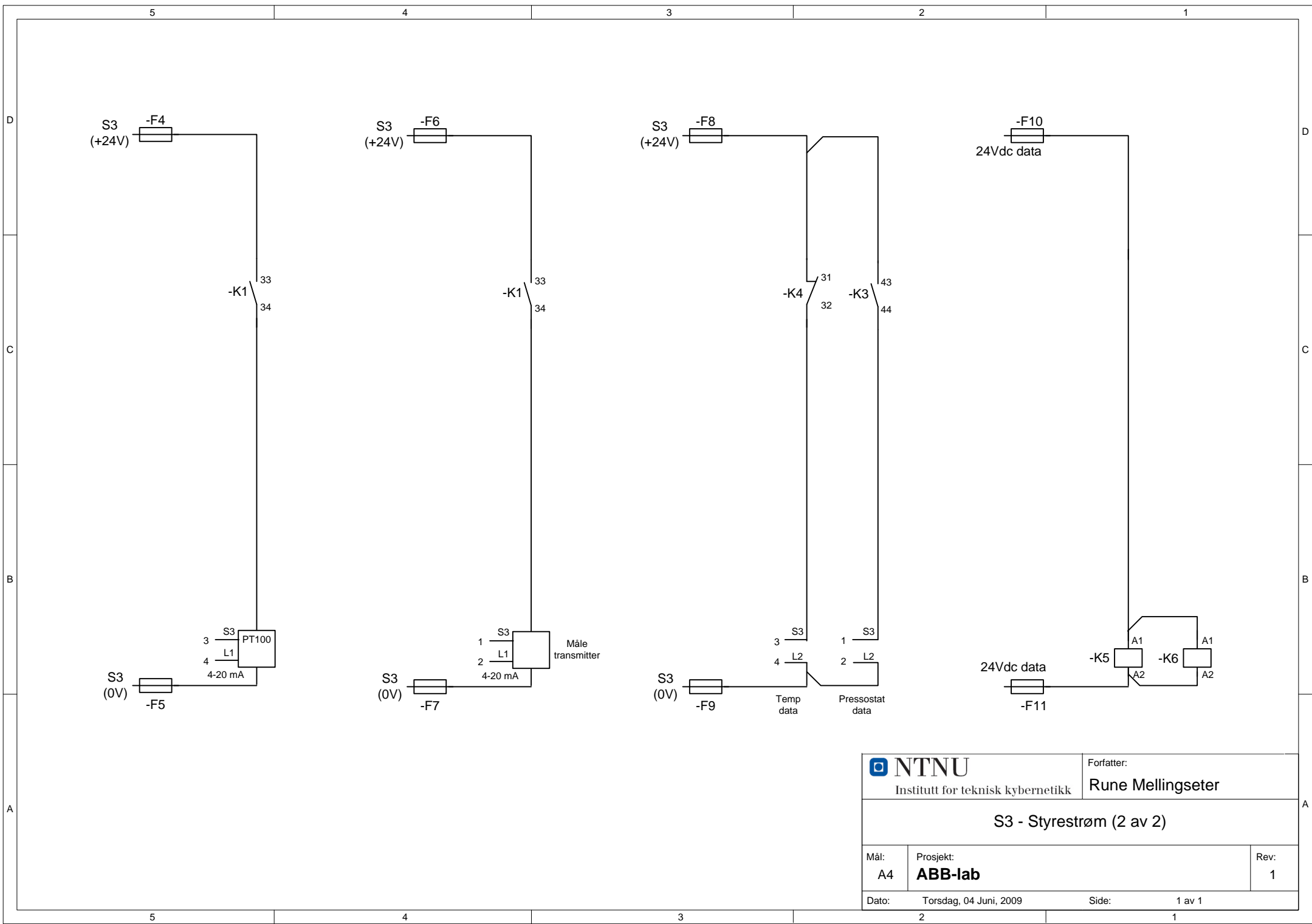

NTNU Institutt for teknisk kybernetikk		Forfatter: Rune Mellingseter	
S3 - Styrestrøm (2 av 2)			
Mål:	Prosjekt:		Rev:
A4	ABB-lab		1
Dato:	Torsdag, 04 Juni, 2009	Side:	1 av 1

5

4

3

2

1

D

D

C

C

B

B

A

A

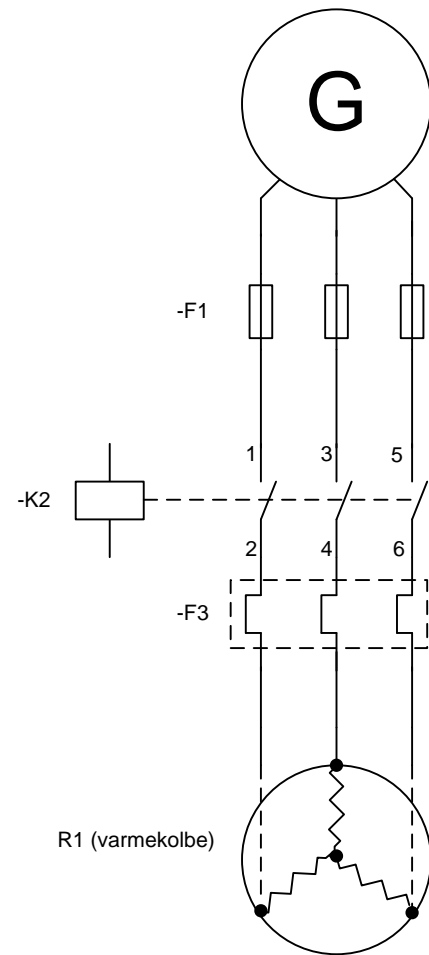

 NTNU Institutt for teknisk kybernetikk		Forfatter: Rune Mellingseter
S3 - Hovedstrøm		
Mål: A4	Prosjekt: ABB-lab	Rev: 1
Dato:	Torsdag, 04 Juni, 2009	Side: 1 av 1

5

4

3

2

1